

RE:FELT

EASYRAIL  
ACOUSTIC BAFFLE  
SYSTEMS  
INSTALLATION GUIDE

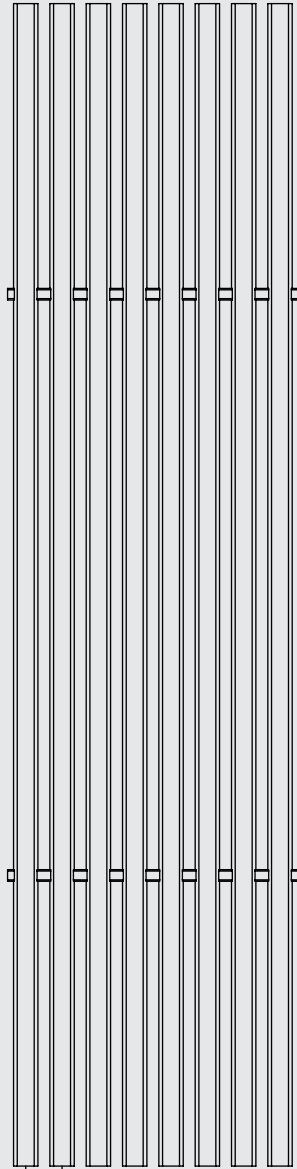

## PARTS

---

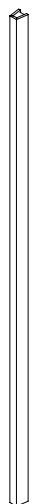

8x  
Baffles

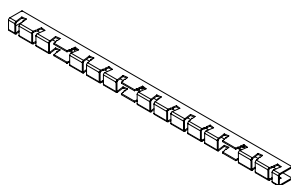

2x  
EasyRail



Make sure you use the correct kind of mounting materials for the ceiling material

Not included



4x  
Screws  
4x40\*



4x  
Plugs

\* Recommended minimum size

## TOOLS

---

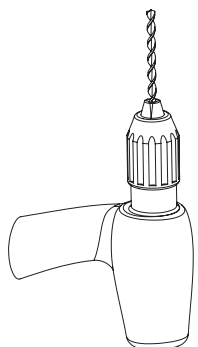

Drill\*

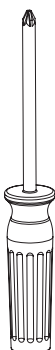

Screwdriver\*

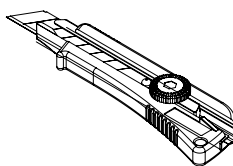

Snap-off  
blade cutter

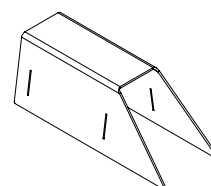

Cutting tool\*\*

\* Tool can vary depending on the type of surface

\*\* Optional

# INSTALLATION

- 1 Mount the EasyRails on the wall or ceiling on the positions indicated below. You can deviate 50 mm up or down from the recommended mounting position. Make sure the EasyRails are aligned vertically.

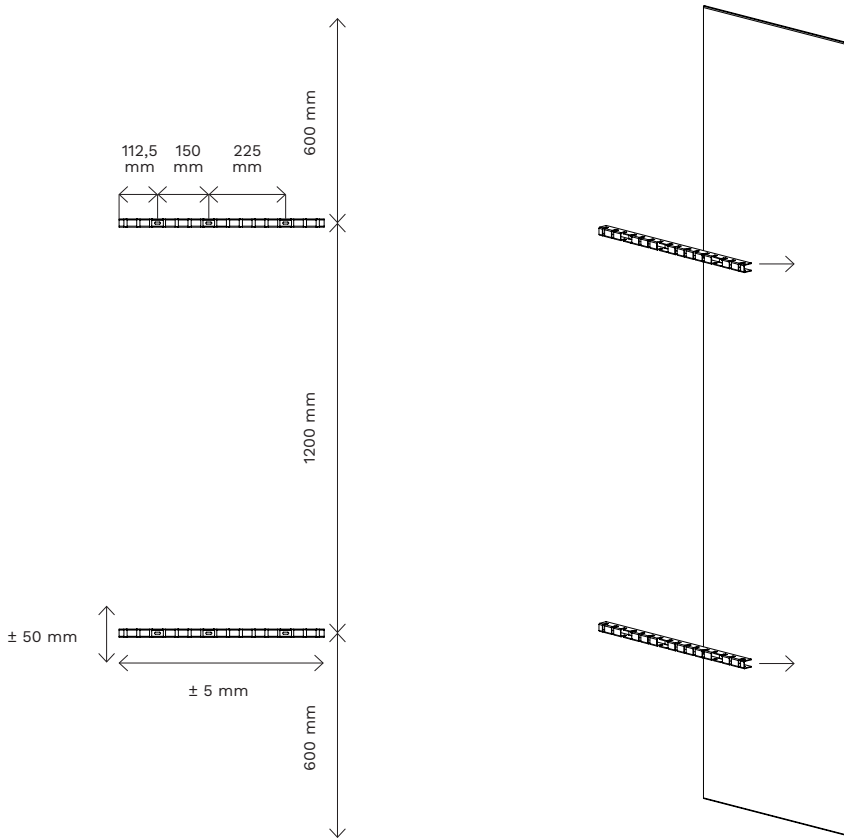

! To increase the acoustic performance of the baffles we recommend to install a PET Felt panel underneath (see installation guide for the PET Felt Panels). If you choose this option, please make sure that the EasyRail is still attached to the underlying surface.

- 2 Push the baffles into the cut-outs of the EasyRail.

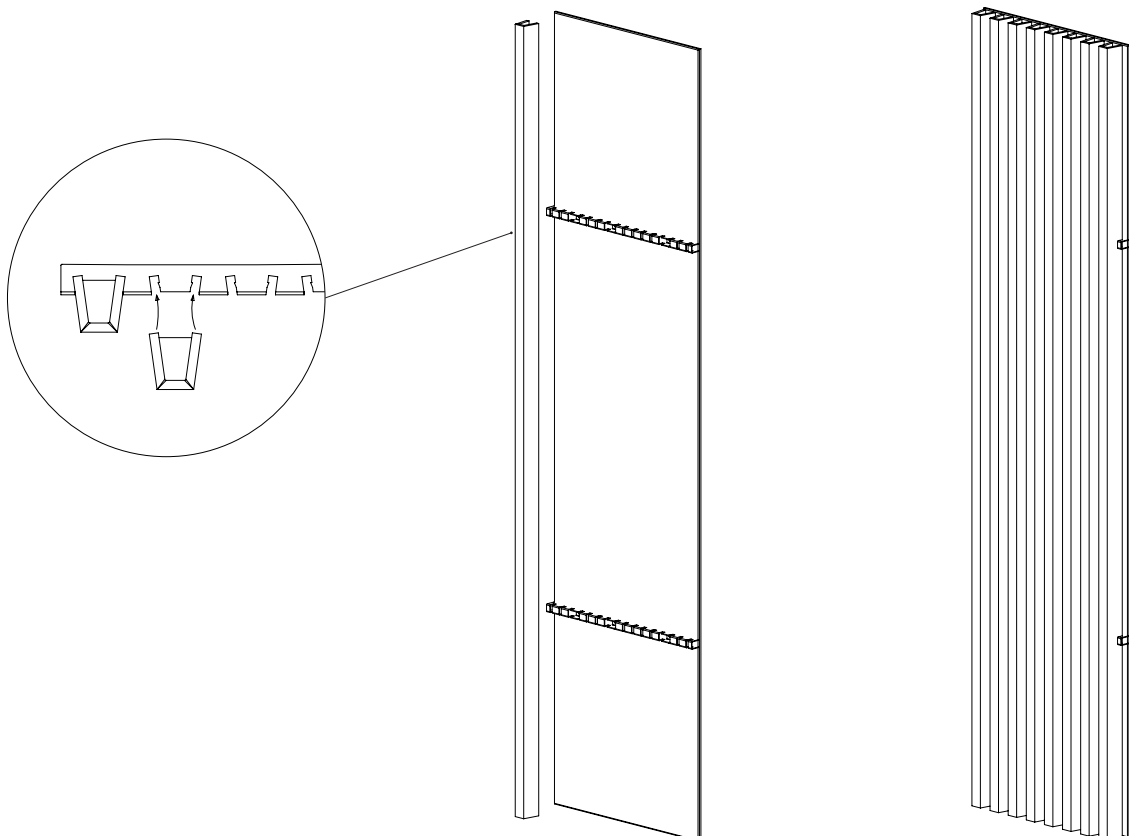

## CUT BAFFLES TO SIZE

---

- ① Use our additional cutting tool to cut the baffles to your preferred size.

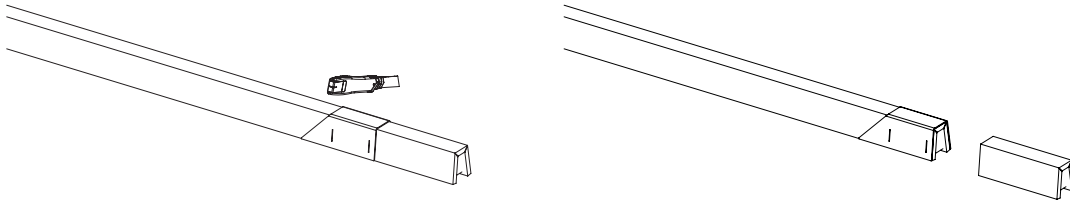

- ② Reverse the tool to cut the baffle in a 45° angle.

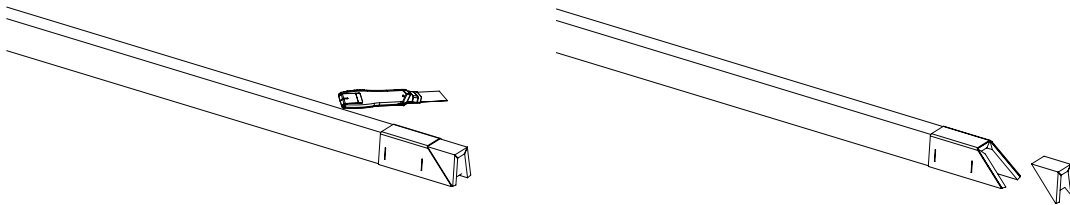

- ③ If needed, make a small incision to remount the connection plate. The incision should be 20 mm.

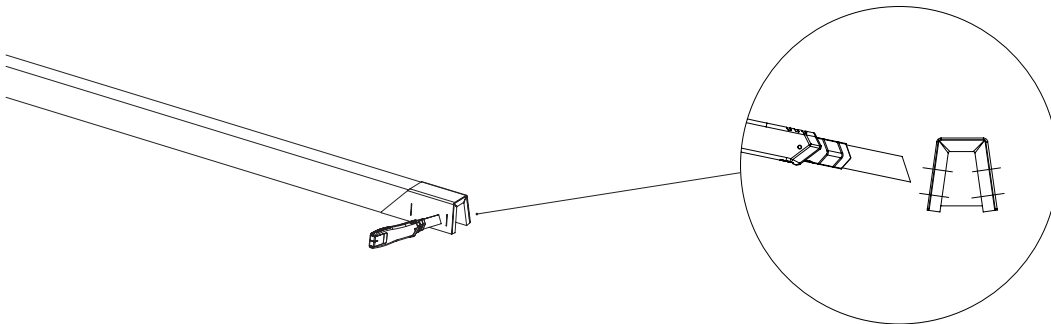

## INSTALLATION IN CORNERS

---

- ① When installing baffles in a corner, make sure to keep a distance of 60 mm from the corner.

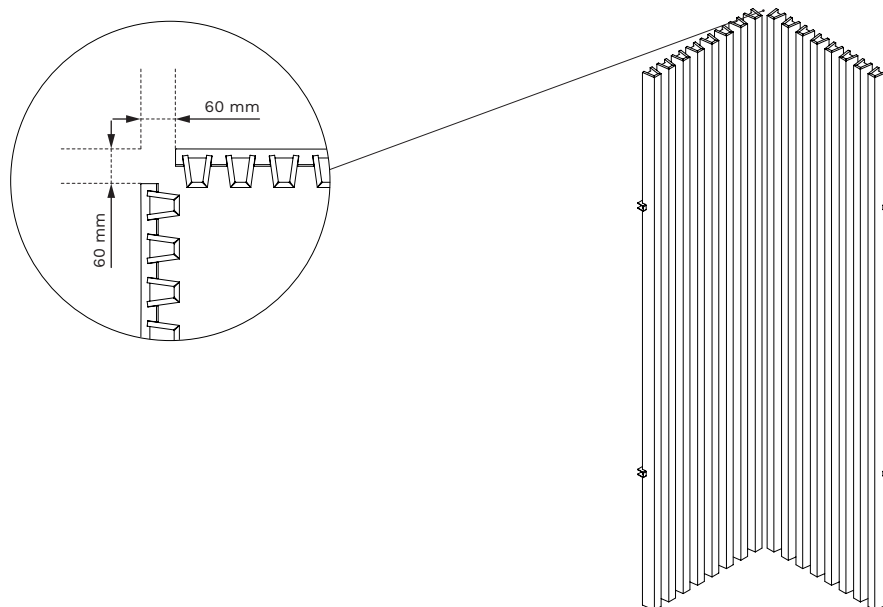

- ② When installing baffles on the wall and ceiling make sure to cut them in a 45° angle. This can be done with the cutting tool. Keep 10 mm distance between the baffle systems.

